

PROGRAMMABLE NUMERIC CONVERTER

**CNL35
CNL35/S2, CNL35/R
CNL35/F, CNL35/T**

CONFIGURATION HANDBOOK

LOREME 12, rue des Potiers d'Etain
Actipole BORNLY - B.P. 35014 - 57071 METZ CEDEX 3
Phone 03.87.76.32.51 - Fax 03.87.76.32.52
Contact: Commercial@Loreme.fr - Technique@Loreme.fr

TABLE OF CONTENTS

DIALOGUE - TERMINAL MODE	page 2
1) PSION Workabout	page 2
2) PC with DOS	page 2
3) PC with WINDOWS 3.11	page 3
4) PC with WINDOWS 95/98	page 3
5) Visualization	page 3
DEVICE PRESENTATION	page 3
CONFIGURATION	page 4
1) Method	page 4
1.1) Menu selection	page 4
1.2) Parameter selection	page 4
1.3) Value acquisition	page 4
1.4) Remarks	page 4
2) Input	page 4
3) Analogs outputs	page 5
4) Special functions	page 5
5) Relay	page 6
OFFSET MEASURE	page 6
EMC CONSIDERATION	page 7
1) Introduction	page 7
2) Installation and utilization rules	page 7
2.1) General remarks	page 7
2.2) Power supply	page 7
2.3) Inputs / Outputs	page 7
TERMINAL-DEVICE LINK	page 7
WIRING DIAGRAM	page 8

DIALOGUE - TERMINAL MODE

Numeric devices can converse with all terminal emulation mode systems. As the dialogue and configuration being resident in device memory, no software or specific interface are necessary for their configuration.

Two terminal emulation mode systems are presented: the PSION and the PC. Different procedures are enumerated below.

1) PSION Workabout:

To start up the PSION push the "**ON**" key.

At the presentation, push the "**MENU**" key. Select "**SYSTEME SCREEN**" mode and validate by "**ENTER**".

Icons display: **DATA CALC SHEET PROGRAM COMMS**

Select icon "**COMMS**" and validate by "**ENTER**", on display, a cursor is flashing. The **PSION** is in terminal mode. Plug the RS232 connection. The measure is displayed and, for configuring, push "**C**" on keyboard.

To quit terminal mode and switch off PSION, push the "**OFF**" key. When you restart the **PSION** in terminal mode, it will be configured automatically and directly in terminal mode without configuring it again.

2) PC with DOS:

The terminal emulation mode software with DOS "**IBM@-PC KERMIT-MS V2.26**" is available at simple request. After the PC has booted, type "**a: K**" then press "**ENTER**". The PC is in terminal mode and uses COM port 1.

If you want to use the second serial communication port (COM2), type:

"**A:KERMIT**" and "**ENTER**" to start program,

"**SET PORT 2**" and "**ENTER**" to select **COM2**,

"**SET BAUD 9600**" and "**ENTER**" to select speed,

"**CONNECT**" and "**ENTER**", to enter in terminal mode.

The PC is now in terminal mode and may be connected to the device by plugging in the RS232 link cable. Measure is displayed and configuration's acces is allowed by a press on "**C**" key.

To quit kermit, press "**CTRL-\$**" then press on "**C**" key. When the message KERMIT-MS appears, type "**QUIT**" to return to MS-DOS commands.

3) PC with WINDOWS 3.11:

Start **WINDOWS** and in "**ACCESSOIRES**" group, double-click on  icon which get access to terminal mode.

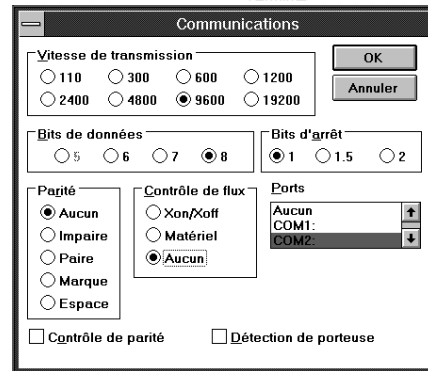

In "**PARAMETRES**" menubar, click on "**COMMUNICATION**" sub-menu. We access to the following windows. Configure communication parameters, 9600 bauds, no parity, 8 data bits, 1 stop bit, no flow control and validate.

Begin terminal emulation by click on "**PARAMETRES**", then on "**EMULATION TERMINAL**". The following board is displayed.

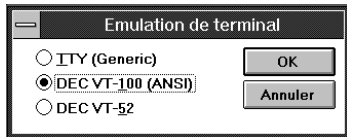

Choose terminal mode **DEC-VT-100(ANSI)** and validate. The PC is in terminal mode, connect it to device by plugging the RS232 link cable. Measure is now displayed and to access at configuration, press on "**C**" key.

4) PC with WINDOWS 95/98:

To start up terminal program:

- 1 - Click on "**START**",
- 2 - Tick off "**PROGRAMS**", "**ACCESSORIES**", and "**HYPER TERMINAL**",
- 3 - Double click or 

Hypertrm.exe



Choose a communication Com port and validate.

The following window is displayed. Enter a name for a new connection and validate, the hereunder window will appears.



The following window is displayed.

Set the communication parameters to 9600 bauds, no parity, 8 data bits, 1 stop bit, no flow control and validate.

The PC is in terminal mode, connect it to device with the RS232 link. The measure is now displayed and for configuration, press the "**C**" key .

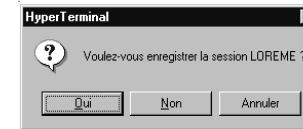

When leaving, HyperTerminal will display the following window. To dialog with all LOREME devices without restart the method, click "**OK**"



So, by the way of  LOREME.ht icon or by its short cut , it will be possible to communicate with all LOREME devices.

5) Visualization:

When switching on, device is automatically put in measure mode.

2 informations are available on screen:

10 mV	Input measure value
11.99 mA	Output result value

To access configuration, push "**C**" on keyboard and follow configuration procedure.

DEVICE PRESENTATION

The purpose of this configuration handbook is to become familiar with the functions supplied by the device.

It's necessary to notice the differences between all the models:

- CNL 35:** universal input, more than 10 types, 1 analog output.
- CNL 35 /S2:** 2 insulated analogs outputs, independently configurables.
- CNL 35 /F:** intended for frequency input, 1 analog output.
- CNL 35 /R:** 2 relays, 1 analog output.
- CNL 35 /T:** response time option, 1 analog output.

Remark: Options **/R** and **/S2** can't be taken simultaneously !

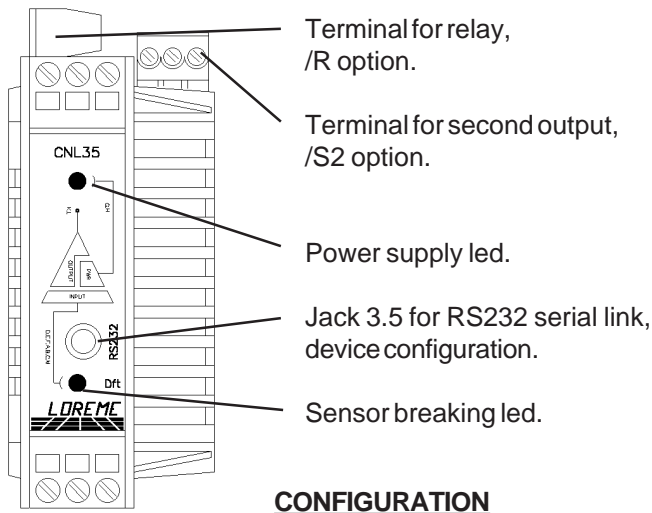

CONFIGURATION

This manual resume in detail the possibilities of configuration: input, output 1, output 2, specials functions, relay 1, relay 2.
To access configuration mode, type the "C" key.

1) Method:

In configuration, different types of questions are asked. For each of them, several answers are possible. Here is their description:

1.1) Menu selection:

Example: INPUT
Y - N

The choice is done by typing the "Y" or "N" keys.

This choice allows access to different configuration menus.

1.2) Parameter selection:

Example: VOLTAGE or VOLTAGE
(Y-N) YES (Y-N) NO

Previous choice = YES: - type "Y" => validation, choice = YES,
- type "Enter" => validation, choice = YES,
- type "N" => change, choice = NO.

Previous choice = NO: - type "N" => validation, choice = NO,
- type "Enter" => validation, choice = NO,
- type "Y" => change, choice = YES.

Choices are made by typing "Y" or "N" keys, and validation by typing displayed answer ("Y" for YES and "N" for NOT) or by "Enter". Typing "Enter" key without modification allows to validate previous answer.

1.3) Value acquisition:

Example: LOW SCALE
4 mA

Two possibilities:

- The validation without modification by typing "Enter",
- The modification with simultaneous display followed by validation with "Enter" key.

It is possible, when a mistake is made during a value acquisition, before validating it, to go back by pressing on "DEL" key. This re-displays the message without taking notice of the mistake.

1.4) Remarks:

- In configuration mode, if there is no action during 2 minutes, device goes back in operating mode without taking notice of the modifications made before.

- In configuration mode, if you want go back to measure mode without taking notice of modifications made before, just press "ESC".

2) Input:

The input possibilities are:

- Voltage (mV, V),
- Current (mA),
- Resistance (Ω),
- Frequency (Hz),
- Pt 100 ($^{\circ}\text{C}$), linearized or not,
- Thermocouple ($^{\circ}\text{C}$), linearized or not,

and for each input type, low and high scale choice.

Particularities:

- Thermocouple:

Choice of thermocouple type, B, E, J, K, R, S, T (another on request).

Choice of compensation type, internal or external.

Choose **internal compensation** when thermocouple is extended up to device with a compensation cable.

Choose **external compensation** when thermocouple is not extended up to device with a compensation cable, but up to a compensation box where temperature will be known and stabilized. This is the value of temperature that will be typed as the external compensation value.

- Differential voltage (mV):

To realize a gauge bridge measure, select the differential mV voltage input. Characteristics as sensitivity and gauge bridge power supply (2.5 V when device provides it) are necessary for measure scale adjust:

Example: sensitivity 2 mV/V,
power supply 2.5 V.

measure scale for signal full range is:

- low scale: -5 mV,
- high scale: 5 mV.

See wiring diagram for gauge bridge wiring.

- Potentiometer:

Configure voltage input (V):

- low scale: 0 V,
- high scale: 2.5 V.

Move potentiometer at the start and at the end of range, notice each value.

Change voltage input (V):

- low scale = start range value,
- high scale = end range value.

See wiring diagram for potentiometer wiring.

- Sensor power supply:

To supply a converter in 2 wires mode and measure current in the loop, it's necessary to configure device in 4-20 mA current input.

See wiring diagram for sensor power supply and current input wiring.

3) Analogs outputs:

In standard, device provide only one analog output. It can, by /S2 option, provide a second output. These outputs, insulated between themselves, are independently configurable.

Analog outputs configuration is presented through 2 rubrics:

- Output type:

- current output (mA),
- voltage output (V).

and for each output type, low and high scale choice.

- Output parameters:

- security value,
- limitation,
- response time.

The security value allows to set the output on a known state when there is a sensor breaking or a measure range overflow.

This value will be transferred to analogical output.

The limitation allows, for all input signal values, to peak clip the output signal swing at scale configuration.

Only security value goes beyond this function.

The response time is adjustable from 300 ms to 60 s. Option /T allows to reduce to 60 ms for a frequency input and to 40 ms for other inputs.

4) Specials functions:

Device disposes of several functions says "special" allowing to personalise device fonctionnement.

The **square root** function executes a square root on the input range percentage. The result is reported on analog output.

The **special linearization** function allows to personalise a response curve by the configuration of correspondance points between measured input signal and analogical output.

When this function is choosed, it is directly validated, but linearization points are not modified. To modify linearization points, it is necessary to validate by YES the configuration suggest.

When **special linearization** is enabled, device uses linearization curve corresponding to configured points (2).

To personalise a response curve (2), it's necessary to set for each curve point the input value and the corresponding output value (maxi 26 points including input points 0 % and 100 %). So, for each measured point, device will make corresponding of linearized output value.

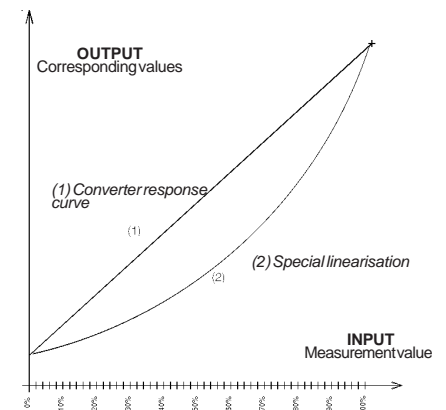

5) Relays:

Device can, by /R option, provide two independently configurables alarm relays. Relays configuration is presented through 2 rubrics:

- Detection type:
 - breaking detection,
 - threshold detection.

The breaking detection activates alarm on sensor breaking or on measure range overflow.

The threshold detection activates alarm on threshold overstepping. It is necessary to choose threshold type, high or low, threshold and hysteresis values.

The two **detections types** can be chosen simultaneously.

The **threshold detection** works in this manner:

- **high threshold** detection:
 - .alarm is activated when measure goes above threshold,
 - .alarm is removed when measure goes below threshold less hysteresis.
- **low threshold** detection:
 - .alarm is activated when measure goes below threshold,
 - .alarm is removed when measure goes above threshold more hysteresis.

- Relay parameter:
 - security,
 - delay.

The security works in this way:

- in **positive** security, relay is energized when alarm is active,
 - ."works" contact is closed on alarm, opened out of alarm,
 - ."back" contact is opened on alarm, closed out of alarm.
- in **negative** security, relay is energized when alarm is inactive,
 - ."works" contact is opened on alarm, closed out of alarm,
 - ."back" contact is closed on alarm, opened out of alarm.

The delay value, configurable from 0 to 60 s, determines the time above which alarm changes his state after event appearance and disappearance. Device provide for each relay a configurable delay when alarm is activated and when alarm is removed.

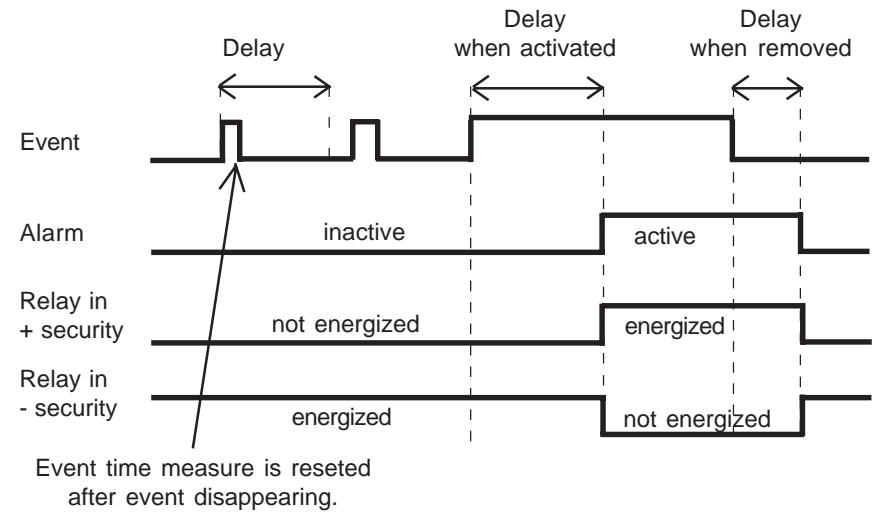

OFFSET

Sometimes, it may be interesting to modify measure by a simple terminal keyboard intervention. It can be used in many situations as a sensor's degradation or to calibrate the input with magnifying effect to obtain a better accuracy in the measure window.

To shift the measure, it is necessary:

- to be in measure mode,
- type on "+" or "-" to access at the function,
- on terminal display become:
 - 100.5 DC** measure value with offset,
 - OFFSET 10** offset function, offset value.
- use keys "+" and "-" to adjust offset, measure is directly modified.
- type on "ENTER" to memorize offset.

When device is not supplied or in configuration mode, offset stay active. To reset offset, it is necessary to start "OFFSET" function, put this value to zero by keys "+" and "-", then validate by "ENTER". In offset control mode, when there is no action on keys "+", "-" or "ENTER" during 20 s, device exits of this mode without to keep adjusted offset.

EMC CONSIDERATION

1) Introduction

In order to insure its policy concerning EMC, based on the European directive 89/336/CE, LOREME takes into account all the standards relative to this directive as soon as the design of each device starts.

All the tests made on our devices, designed to work in industrial plants, have been made regarding the EN 50081-2 and EN 50082-2 standards in order to edit a conformity certificate.

It is difficult to guarantee all the results concerning EMC because tests are made in a standard and typical configuration. Results may vary when a change of configuration occurs.

In order to be sure to use all the capabilities of the device, it will be necessary to respect a few rules concerning its installation.

2) Installation and utilization rules

2.1) General remarks

- Installation should be made with respect to the informations given in technical documents (installation, spacing between each device ...).
- Utilization conditions should be in accordance with specifications of the transmitter (temperature range, protection level) specified in technical datasheet. Dust, excessive humidity, corrosives atmospheres or important heat sources should be prohibited in order to insure an optimum utilization.
- Noisy environment or elements creating perturbations should be avoided. If it is possible, it will be better to install instrumentation devices separately from hi-power or commutation devices.
- Do not install measurement devices close to hi-power relays, thyristor groups, contactors or all electromagnetic noise generators.
- Do not use a portable transmitter (walkie-talkie) at less than 50 cm of the device. A 5 W transmitter may generate a field which intensity may be more than 10 V/ m at a distance near of 50 cm.

2.2) Power supply

- At first, it's important to install the equipment with respect to the technical specifications given in the device's datasheet (supply voltage, frequency, tolerance of values, stability, variations ...).
- The power supply of the device should be issued from a supply system using section switches and fuses made for instrumentation devices, and the supply line should be as direct as possible from section switch.
- Don't use this power supply for relays, contactors or valves command.

- An isolating transformer, with its screen shorted to ground may be necessary if the supply circuit is made noisy with commutation of thyristors, relays, motors, speed variators ...
- It's important that the installation has to be connected to ground. The voltage between neutral and earth must be less than 1 V and the resistance must be less than 6 Ohms.
- If the equipment has been installed near hi-frequency generators or arc welding installations, it may be useful to install adequate filters on the mains supply.

2.3) Inputs / Outputs

- In a noisy environment, it will be better to use shielded and twisted wires. The ground connection will be made at a single end of the wire.
- I/O lines should be well separated from supply wires in order to avoid coupling between these wires.
- Data wires length should be as short as possible.

TERMINAL - DEVICE LINK

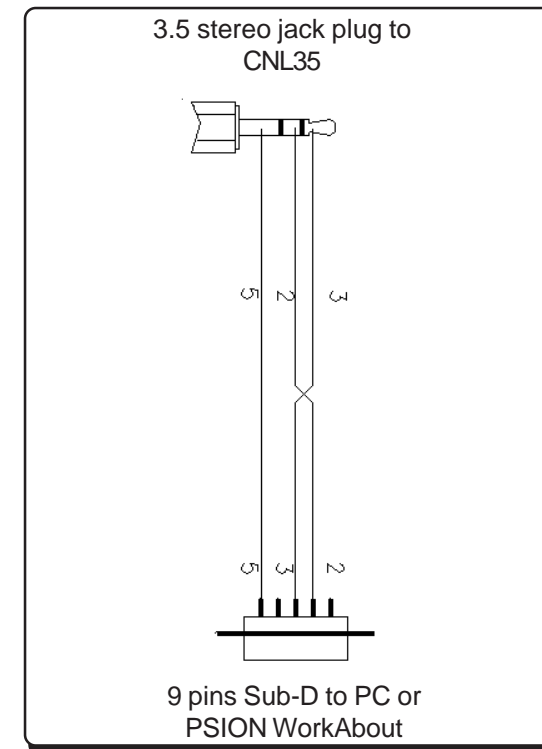

WIRING DIAGRAM

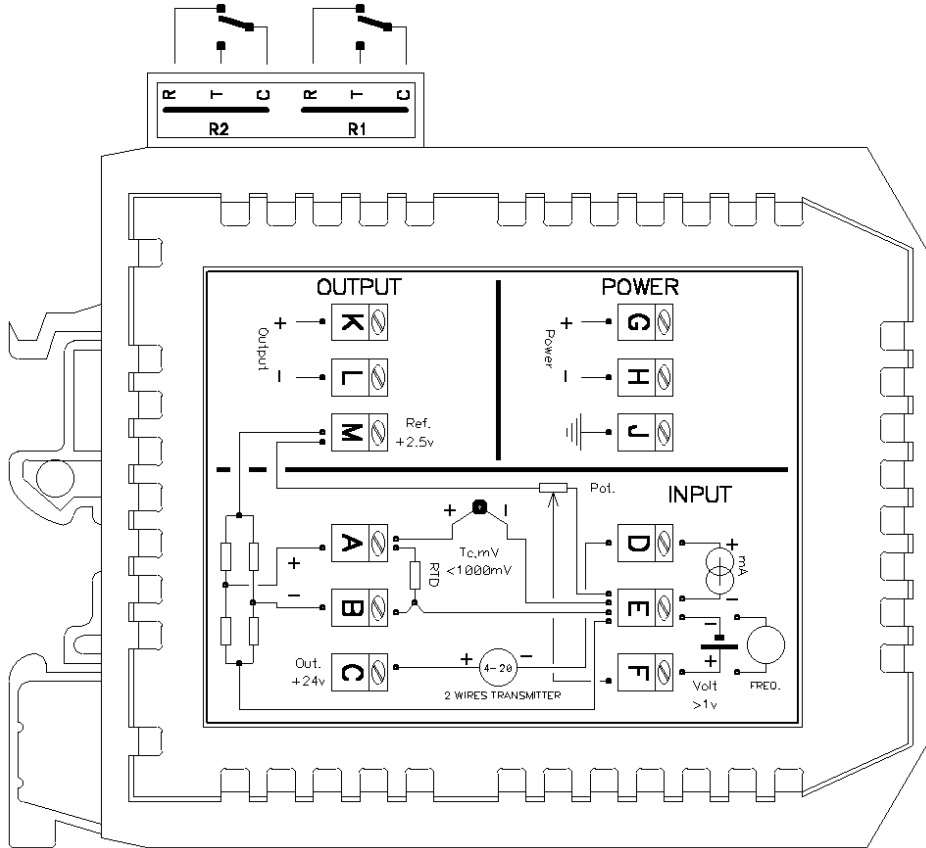

mV, Tc input:

terminal A (+), terminal E (-)

V input:

terminal F (+), terminal E (-)

Potentiometer input:

terminal M (supply), terminal F (+), terminal E (-)

Strain gauge input :

terminal M (supply +), terminal E (supply -)

terminal A (measure +), terminal B (measure -)

mA input:

terminal D (+), terminal E (-)

Sensor supply input:

terminal C (+), terminal D (-)

Resistance, Pt100 input (2-wires):

terminal A (+), terminal E (-) and B (-)

Resistance, Pt100 input (3-wires):

terminal A (+), terminal E (-), terminal B (line)

Frequency input:

terminal F (+), terminal E (-)

Analog output 1:

terminal K (+), terminal L (-)

Analog output 2:

terminal OUT2 (+), terminal OUT2 (-)

Relay 1:

terminal R1 (rest), terminal T1 (work)

terminal C1 (common)

Relay 2:

terminal R2 (rest), terminal T2 (work)

terminal C2 (common)

Power supply:

terminal G (+), terminal H (-)